



COMMUNITY DEVELOPMENT

333 Broadalbin Street SW, PO Box 490, Albany, Oregon 97321-0144 | BUILDING & PLANNING 541-917-7550

Staff Report

Historic Review of New Construction

HI-12-23

August 30, 2023

Summary

This staff report evaluates a Historic Review of New Construction for a residential accessory structure on a developed lot within the Monteith National Register Historic District (Attachment A). The applicant proposes to construct an accessory building in the front yard.

Application Information

Review Body:	Landmarks Commission (Type III review)
Staff Report Prepared By:	Alyssa Schrems, Planner II
Property Owner/Applicant:	Jacob & Lindsey Thompson; 640 4th Avenue SW, Albany, OR 97321
Address/Location:	640 4th Avenue SW, Albany, OR 97321
Map/Tax Lot:	Linn County Tax Assessor's Map No. 11S-04W-12AA-04400
Zoning:	Hackleman Monteith (HM) District (Monteith National Register Historic District)
Total Land Area:	6,767 square feet
Existing Land Use:	Single Unit Residential, accessory duplex
Neighborhood:	Central Albany
Surrounding Zoning:	North: HM- Hackleman Monteith East: HM- Hackleman Monteith South: HM- Hackleman Monteith West: HM- Hackleman Monteith
Surrounding Uses:	North: Residential, Power Station, Water Treatment Plant East: Residential, Single Unit South: Residential, Single Unit West: Residential, Single Unit
Prior History:	HI-04-03: Replace back door stairs (rotted off and currently removed) located on the east side of the house. HI-11-11: Exterior alterations to replace missing windows and doors on the south side, replace non-original windows on the east side, install new window and skylight not visible from the street. HI-02-14: Exterior alterations to restore exterior building features as determined by earlier photographs and other evidence.

Notice Information

On August 16, 2023, a notice of public hearing was mailed to property owners within 100 feet of the subject property. On August 28, 2023, notice of public hearing was posted on the subject site. As of August 28, 2023, no public testimony has been received.

Analysis of Development Code Criteria

Historic Review of New Construction (ADC 7.270)

The Community Development Director or the Landmarks Commission must find that the request meets the following applicable criteria in order to approve the new construction request.

Within the Monteith and Hackleman Districts (ADC 7.270(1))

- a. **The development maintains any unifying development patterns such as sidewalk and street tree location, setbacks, building coverage, and orientation to the street.**
- b. **The structure is of similar size and scale of surrounding buildings, and as much as possible reflects the craftsmanship of those buildings.**
- c. **Building materials are reflective of and complementary to existing buildings within the district.**

Findings of Fact

- 1.1 Unifying Development Patterns (ADC 7.270(1)(a)): The applicant proposes to construct a 12-foot by 16-foot (192 square feet) accessory structure for tool storage in the front yard of the subject property. The primary dwelling on the subject property was constructed in 1870 with a major remodel in 1920. The style of the structure is vernacular, with decorative features consisting of a gable dormer over the front porch, a gable dormer on the east side of the structure and an interior chimney (Attachment B.1).

The applicant states “there are many homes with a range of different characteristics in this area. Some have street trees, some do not. Some homes face 4th street, others face the alley, and several lots in the area are industrial (such as the power plant/water treatment plant) or vacant. There are a number of homes with storage sheds, garages, basements, and garages converted to separate living units as well” (Attachment C.2.1).

The applicant’s site plan indicates that the proposed accessory structure would be located approximately 15 feet from the front property line. The porch of the house is shown as being 18 feet from the front property line and the house located approximately 26.5 feet from the front property line. An aerial review one block in each direction does not indicate that there are accessory structures located in the front yard of any homes (Attachment D.1). The development pattern of the area has accessory structures generally located in the back yard, with access from the alley. Based on the evidence currently in the record, locating an accessory structure in the front yard as the closest structure to the front property line does not maintain the current development pattern. The applicant shall have an opportunity to address this criterion in further detail at the hearing.

- 1.2 Size and scale (ADC 7.270(1)(b)): The applicant states that “the size/scale of buildings around the area consist mostly of 2 story homes with many having detached garages, sheds, and/or ADU’s” (Attachment C.2.1). Based on aerial imagery, there appear to be eight outbuildings on the same block as the subject property. The largest accessory structure is approximately 1,000 square feet in size (432 Calapooia Street SW) and the smallest is approximately 185 square feet in size (617 5th Avenue SW). Based on these facts, the proposed structure appears to match the size and scale of other surrounding accessory structures.

The applicant states that “for this shed, I have chosen to select materials that reflect the craftsmanship of the surrounding buildings as much as possible. For example, the shed will have a gable style roof to match our home, double hung windows, flowerpots under windows, and matching paint/trim with our main home” (Attachment C.2.1). Based on the plans provided by the applicant, the accessory structure has a gable roof and double hung windows, without being designed to create a false sense of time or place. The applicant shall have the opportunity to address this further at the hearing.

- 1.3 Building materials (ADC 7.270(1)(c)): The applicant states “the surrounding homes use a mixture of various building materials. For example, a survey of homes in the area shows that some of the siding used includes dutch lap, clapboard, shake, T-111, brick, and stucco. In some instances, homes use a combination of styles where they have been added on to. Windows appear to be mostly hung, however not all are this way. Roof materials appear to be primarily shingles, with some outbuildings and other structures having flat roofing material. Our shed will have Gable style roof with asphalt shingles, double hung windows, T-111 siding, with conventional stick-built framing. The front door will be a standard 36-inch x 80-inch entry 6 panel steel door. The rear doors will consist of French doors, allowing for larger tools to be taken in/out of the shed. And again, we will paint the shed to match our home” (Attachment C.2.2).

Based on the survey of the surrounding area conducted by the applicant, this criterion appears to be met.

Overall Conclusions

This proposal seeks to construct an accessory building in the front yard of the subject property.

Staff does not find that applicable criteria are met for the new construction.

Options and Recommendations

The Landmarks Commission has three options with respect to the subject application:

Option 1: Approve the request as proposed;

Option 2: Approve the request with conditions of approval;

Option 3: Deny the request.

Based on the discussion above, staff recommends the Landmarks Commission pursue Option 3 deny the request. If the Landmarks Commission accepts this recommendation, the following motion is suggested.

Motion

I move to deny the application for new construction as detailed in planning file no. HI-12-23. This motion is based on the findings and conclusions in the August 30, 2023, staff report and findings made by the Landmarks Commission during deliberations on this matter.

Attachments

- A. Location Map
- B. Historic Resource Survey
- C. Applicant’s Submittal:
 - 1. Historic Review of New Construction Form
 - 2. Additional Findings of Fact
 - 3. Building Plans
 - 4. Site Plan
- D. Aerial Analysis

Acronyms

- ADC Albany Development Code
- HM Hackleman Monteith District

Architectural Terms (Dictionary of Architecture & Construction 2nd Edition)

Gable: The vertical triangular portion of the end of a building having a double-sloped roof, from the level of the cornice or eaves to the ridge of the roof.

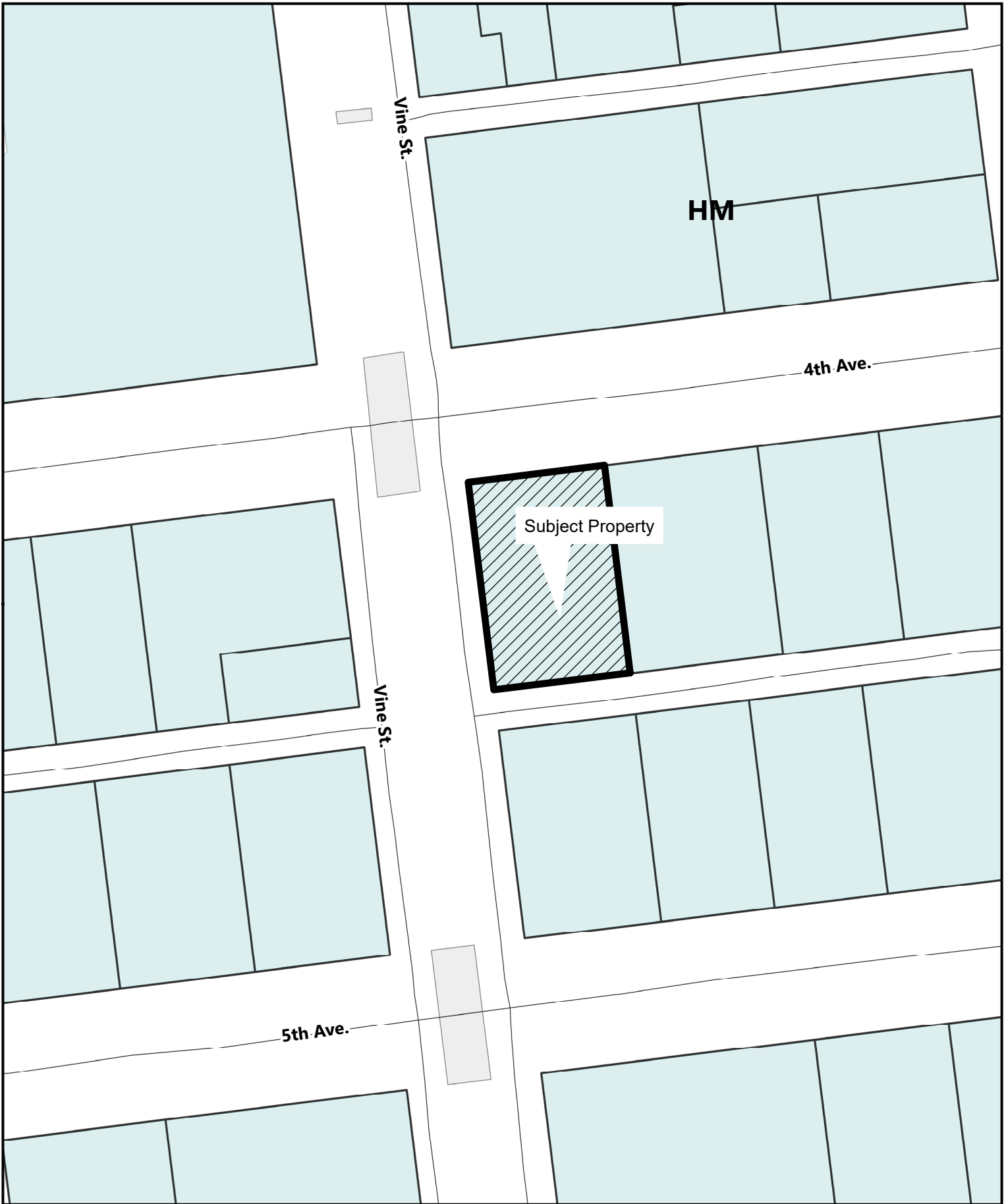

\\con.cityofalbany.net\homes\analysis\ss\Desktop\Notice Map_Template.mxd

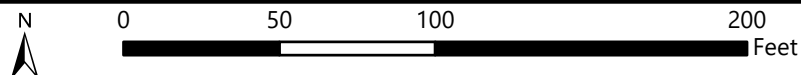

640 4th Ave SW

OREGON INVENTORY OF HISTORIC PROPERTIES
HISTORIC RESOURCE SURVEY - ALBANY
HISTORIC DISTRICT

Attachment B.1

COUNTY: Linn

HISTORIC NAME: None	ORIGINAL USE: Residence
COMMON NAME: None	CURRENT USE: Residence
ADDRESS: 640 4th Ave. SW	CONDITION: Fair
ADDITIONAL ADDRESS: NONE	INTEGRITY: Poor MOVED? N
CITY: Albany	DATE OF CONSTRUCTION: c.1870/1920
OWNER: Lawrence Hobart/Harlow Hosford	THEME 19th Century Architecture
CATAGORY: Building	STYLE: Vernacular
LOCATION Monteith Historic District	ARCHITECT UNKNOWN
MAP NO: 11S04W12AA TAX LOT: 04400	BUILDER: UNKNOWN
BLOCK: 25 LOT 1	QUADRANGLE Albany ASSESSMENT: N
ADDITION NAME: Original Platt	ORIGINAL RATING: Secondary
PIN NO: 11S04W12AA04400 ZONING HM	CURRENT RATING: Historic Contributing

PLAN TYPE/SHAPE: T-shaped	NO. OF STORIES: 1.5
FOUNDATION MAT.: Brick	BASEMENT N
ROOF FORM/MAT.: Cross gable	PORCH: Hipped

STRUCTURAL FRAMING: Wood

PRIMARY WINDOW TYPE: 6/1 double hung

EXTERIOR SURFACING MATERIALS: Asbestos siding

DECORATIVE FEATURES:

Gable dormer over front porch, gable dormer E. side, interior chimney

EXTERIOR ALTERATIONS/ADDITIONS:

Asbestos siding, porch enclosed, front west window enlarged.

*asbestos siding removed, house restoration, new foundation
skylight on S roof not visible from street*

NOTEWORTHY LANDSCAPE FEATURES:

Located along Santiam canal

ADDITIONAL INFO:

Neighbor says this building was old Chinese laundry at one time

INTERIOR FEATURES:

None

LOCAL INVENTORY NO.: M.025

SHPO INVENTORY NO.: None

CASE FILE NUMBER: None HI-11-11

**OREGON INVENTORY OF HISTORIC PROPERTIES
HISTORIC RESOURCE SURVEY
ALBANY**

Attachment B.2

COUNTY : Linn

<p>HISTORIC NAME :</p> <p>COMMON NAME :</p> <p>ADDRESS : 640 4th Ave. SW</p> <p>CITY : Albany</p> <p>OWNER : Lawrence Hobart/Harlow Hosford</p> <p>CATAGORY : Building</p> <p>LOCATION : Monteith Historic District</p> <p>ASSOCIATED FEATURES : 0</p> <p>MAP NO : 11-4W-12AA TAX LOT : 04400</p> <p>BLOCK : 25 LOT : 1</p> <p>ADDITION NAME : Original Platt</p> <p>PIN NO : 11S04W12AA04400 ZONING : HM</p>	<p>ORIGINAL USE : Residence</p> <p>CURRENT USE : Residence</p> <p>CONDITION : Fair</p> <p>INTEGRITY : Poor Moved : N</p> <p>DATE OF CONSTRUCTION : c.1870/1920</p> <p>THEME : 19th Century Architecture</p> <p>STYLE : Vernacular</p> <p>ARCHITECT :</p> <p>BUILDER :</p> <p>QUADRANGLE : Albany</p> <p>LOCAL RANKING : Altered Historic</p> <p>SPECIAL ASSESSMENT : N</p>
<p>PLAN TYPE/SHAPE : "T" NO. OF STORIES : 1.5</p> <p>FOUNDATION MAT.: Brick BASEMENT : N</p> <p>ROOF FORM MAT. : Cross gable PORCH : Hipped</p> <p>STRUCTURAL FRAMING : Wood</p> <p>PRIMARY WINDOW TYPE : 6/1 double hung</p> <p>EXTERIOR SURFACING MATERIALS: PRIMARY EXT : Asbestos siding DECORATIVE : None</p> <p>DECORATIVE : Gable dormer over front porch, gable dormer E. side, interior chimney</p> <p>EXTERIOR ALTERATIONS/ADDITIONS : Asbestos siding, porch enclosed, front west window enlarged.</p> <p>LANDSCAPE FEATURES : Located along Santiam canal</p> <p>OTHER : Neighbor says this building was old Chinese laundry at one time</p>	
<p>RECORDED BY : Roz Keeney DATE : 08/96</p> <p>LOCAL INVENTORY NO. : M.025 SHPO INVENTORY NO. :</p> <p>CASE FILE NO. :</p>	

**OREGON INVENTORY OF HISTORIC PROPERTIES
HISTORIC RESOURCE SURVEY -ALBANY
MONTEITH HISTORIC DISTRICT -PAGE TWO**

Attachment B.3

NAME: Lawrence Hobart/Harlow Hosford
ADDRESS: 640 Fourth Ave. S.W.
QUADRANGLE: Albany

T/R/S: T11-R4W-S12
MAP NO.: 11-4W-12AA
TAX LOT: 4400



NEGATIVE NO.: C-03

SLIDE NO.: MS.025

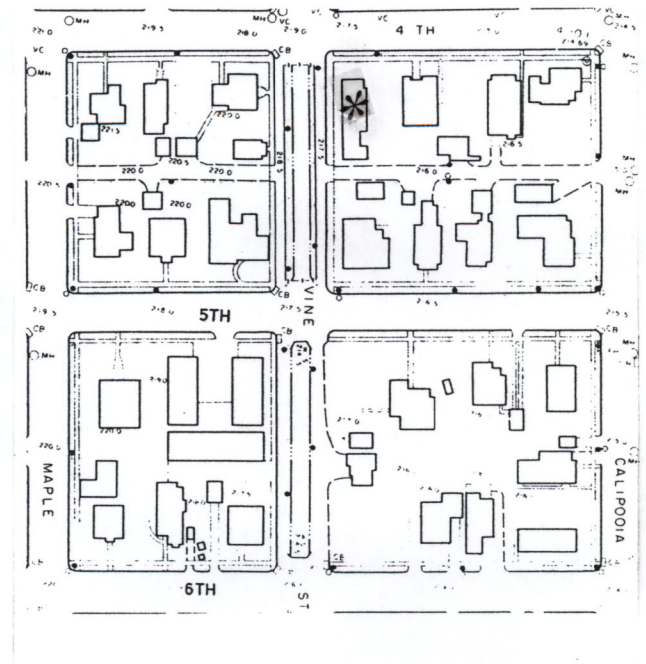
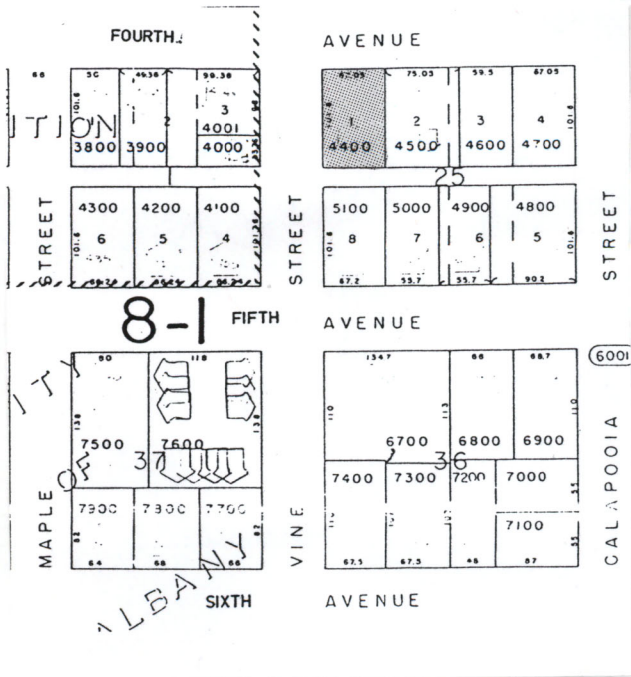

GRAPHIC & PHOTO SOURCES: Albany Community Development Planning Division & Tanya Neel.

PERMITS Id: ASSR105 Keyword: UASSR User: PLANS 08/17/94
Assessor Parcel File Maintenance

Enter Option: I
Parcel No: 11S04W-12-AA-04400 Account No: 0131256

Status: A Active Retired(Y/N): N

Street Address: 640 Dir: SW St: 4TH AVENUE City:

Situs Location: 640 4TH AVENUE SW

Legal Desc:

Acres: .00

X-COORD:

Y-COORD:

Tax Rate Area: 220

ASSR Use Code: 1011 Assessed/Exempt: A

Pub Owned(Y/N): N

Primary Owner: HOBART, LAWRENCE L Phone:

Mailing Addr: C/O HARLOW & FRANCES HOSFORD

1528 SANTIAM HWY

ALBANY, OR

Zip: 973210000

Contract Owner: Percent/Ownership: .00

*** Press any key to continue ***

59. 640 SW Fourth Avenue
Significance: Secondary
Use: Residence
Date: Pre-1900 - additions 1920

John + Vicky Anderson Attachment B.5

Present Owner: ~~Harry McCoy~~
640 SW Fourth Avenue
Tax Lot: 11-4W-12AA-4400

Description:

Two story structure with cross gable roof, interior chimney; two story portico on front elevation. Gable ends which have six over six lights and simple surrounds. Siding is asbestos. Rear side porch.

Remarks: The style is Rural Vernacular - modified, and condition is fair.

640
Fourth

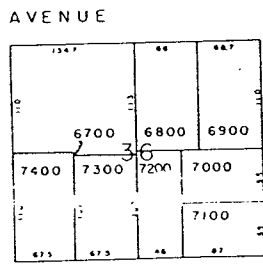
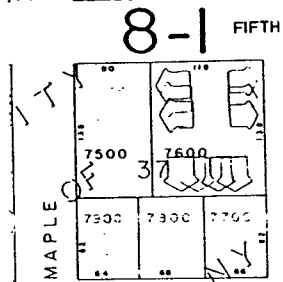
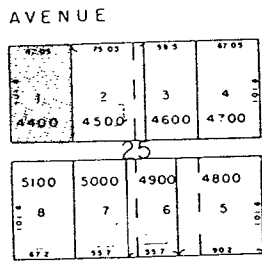
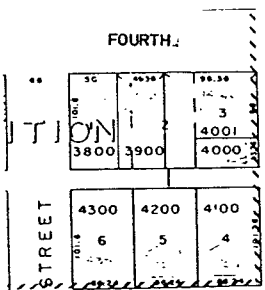

8-1

FIFTH

AVENUE

(600)

CALAPOOIA

AVENUE

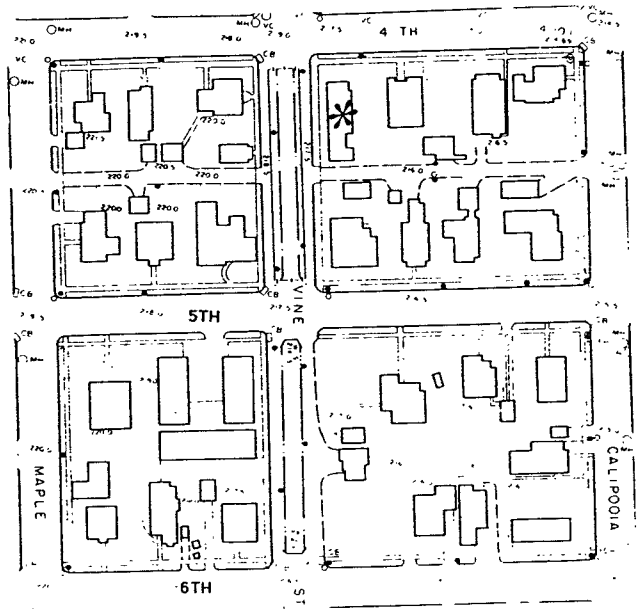

ALBA SIXTH

Attachment B-7
Wayne Garrison

ASN 4

ASBESTOS WASTE SHIPMENT REPORT FORM



PLEASE PRINT OR TYPE! If you have questions, contact your local DEQ Regional Office in Portland at (503) 229-5364, Salem at (503) 378-8240 ext. 272, Medford at (541) 776-6010 ext. 235, or Bend at (541) 388-6146 ext. 226, OR call (800) 452-4011 for the location of your local regional DEQ office.

WASTE GENERATOR: (Contractor, Facility, or Operator)

- Asbestos removal site name and address: 640 4th Avenue SW
Albany, OR Linn 47540
Street City/State County Zip
 Contact person: GAIL PARRESH Phone: 503/910-7336
- Operator's name and address: _____ Phone: _____
Street City/State County Zip
- Waste disposal site: _____ Phone: _____
Street City/State County Zip
- Describe asbestos materials: Non-Friable asbestos cement siding material
- Containers: Number: _____ Type: _____
- Total quantity (cubic yards): _____

7. **OPERATOR'S CERTIFICATION:** I hereby declare that the contents of this consignment are fully and accurately described above by proper shipping name and are classified, packaged, marked and labeled, and are in all respects in proper condition for transport by highway according to all government regulations. All movement of this asbestos-containing material is recorded on this Waste Shipment Record Form.

Name: _____ Company: _____
 Signature: _____ Date: _____

TRANSPORTER(S):

- Transporter #1: (Acknowledgment of receipt of materials)
 Agent: David Tramm Company: _____
 Address: 1018 342nd Ave NW Phone: 5039991528
 Signature: David Tramm Date: Aug 8, 2008
- Transporter #2: (Acknowledgment of receipt of materials)
 Agent: _____ Company: _____
 Address: _____ Phone: _____
 Signature: _____ Date: _____

DISPOSAL: (Certification of receipt of asbestos materials covered by this manifest, except as noted in item 11 below.)

- Waste Disposal Site: Brown Island
 Name and Title: John Drager Date: 8/8/08
 Signature: _____ Phone: (503) 588-5064

11. **DISCREPANCY SPACE:** (Add attachments as needed) _____

*Gayle's new
email
address*

gp9710@gmail.com

Catlin, Anne

From: Gayle M PARRISH [Gayle.M.Parrish@state.or.us]
Sent: Monday, September 22, 2008 11:52 AM
To: Catlin, Anne
Subject: Re: accessory building use - 640 4th Ave SW

Hi, Anne. I am planning to keep two apartments in the second building, just as it is now (one on each floor). I'm not going to use the building for storage or garage purposes.

Also, the Planning Dept. issued the addresses of 409 Vine Street and 411 Vine Street for the two apartments, so that will clear up some of the confusion about them. I'll see if the County will make this change on the Plat Map in their records, so that everyone has the same information. (They had it listed as 638 Vine Street, which appeared to be incorrect.)

Thanks; let me know if you need anything else on this. We should be ready for the electrical inspection on Wednesday or Thursday of this week, so we are making progress!

Gayle Parrish

>>> "Catlin, Anne" <anne.catlin@cityofalbany.net> 9/22/2008 11:42 AM >>>
Hi Gayle,

How are you going to use the second building on your property? The reason I ask is that in this zone, the Code allows one accessory apartment when one unit is owner-occupied (either the main house or the apartment).

I know we have researched when the building was built for historic review purposes, but we never talked about how you were going to use it. The Sanborn Fire Insurance map for 1949 shows that there were 2 units here. I researched the zoning history and this has been zoned single-family for as long as we have records (back into the 40s). The Code allowed accessory units - but it is unclear about an accessory "duplex" and the minimum land area requirements. I just spoke to Planning Manager Don Donovan about this and we decided that if the building has been used as a duplex for 60+ years, that we would allow it, but we need to add the building to the Code's special status list (which grandfather's these things in).

If you are only going to have one unit back there and use the rest for storage/garage/shop, then we don't need to add the building to the special status list.

Let us know how you plan to use the building. Thank you.

Anne Catlin, AICP

Albany Community Development Planner II

PO Box 490; Albany, OR 97321

(541) 917-7560; fax- (541) 917-7598

anne.catlin@cityofalbany.net <<mailto:anne.catlin@cityofalbany.net>>

www.cityofalbany.net

Historic Resources online - www.cityofalbany.net/comdev/historic/

MAY 1895
ALBANY
ORE.

2
THIRD

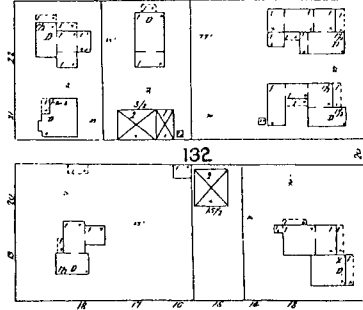
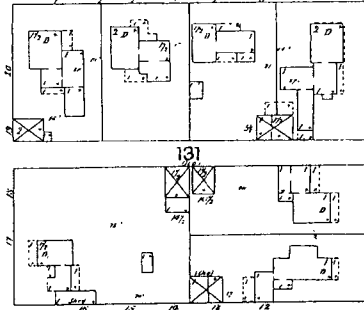
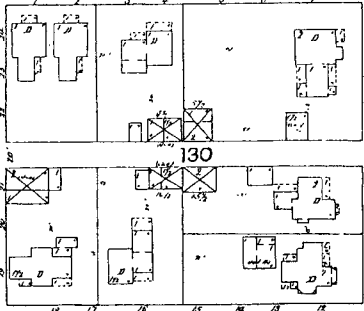

FOURTH

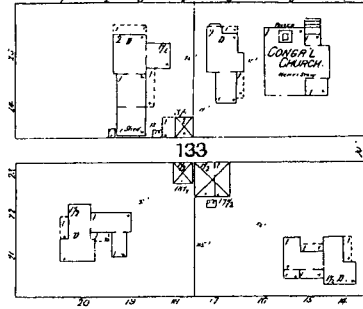
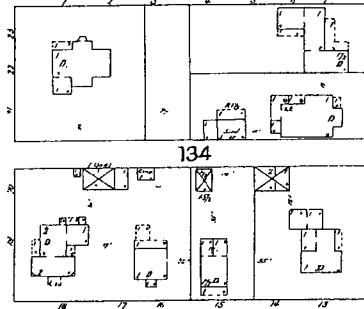
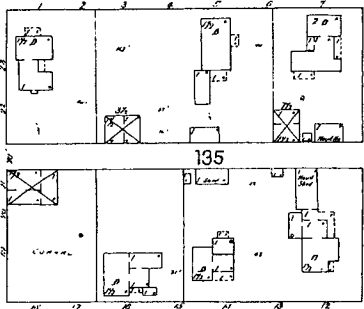

FIFTH

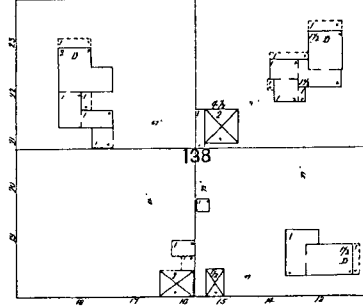
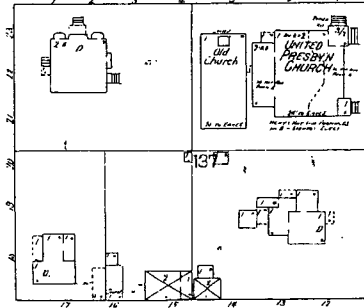
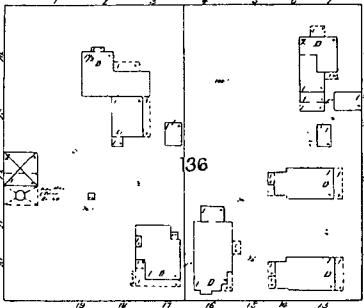

SIXTH

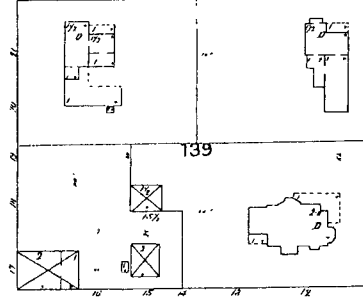
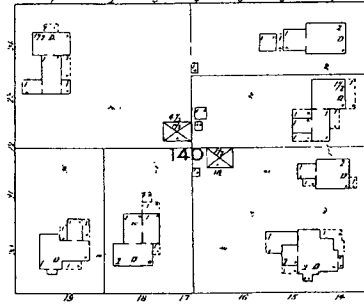
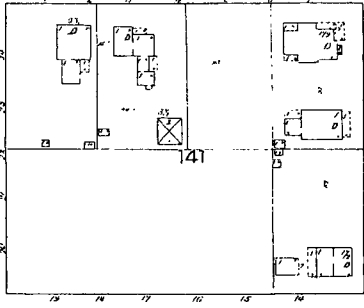

SEVENTH

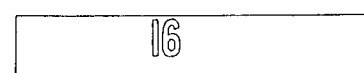

CALLAPOOIA

WASHINGTON

FERRY

88

90

92

94

Scale of Feet
30

MAY 12 '55
Library of Congress

1000000

SEP 1888
ALBANY
ORE.

8

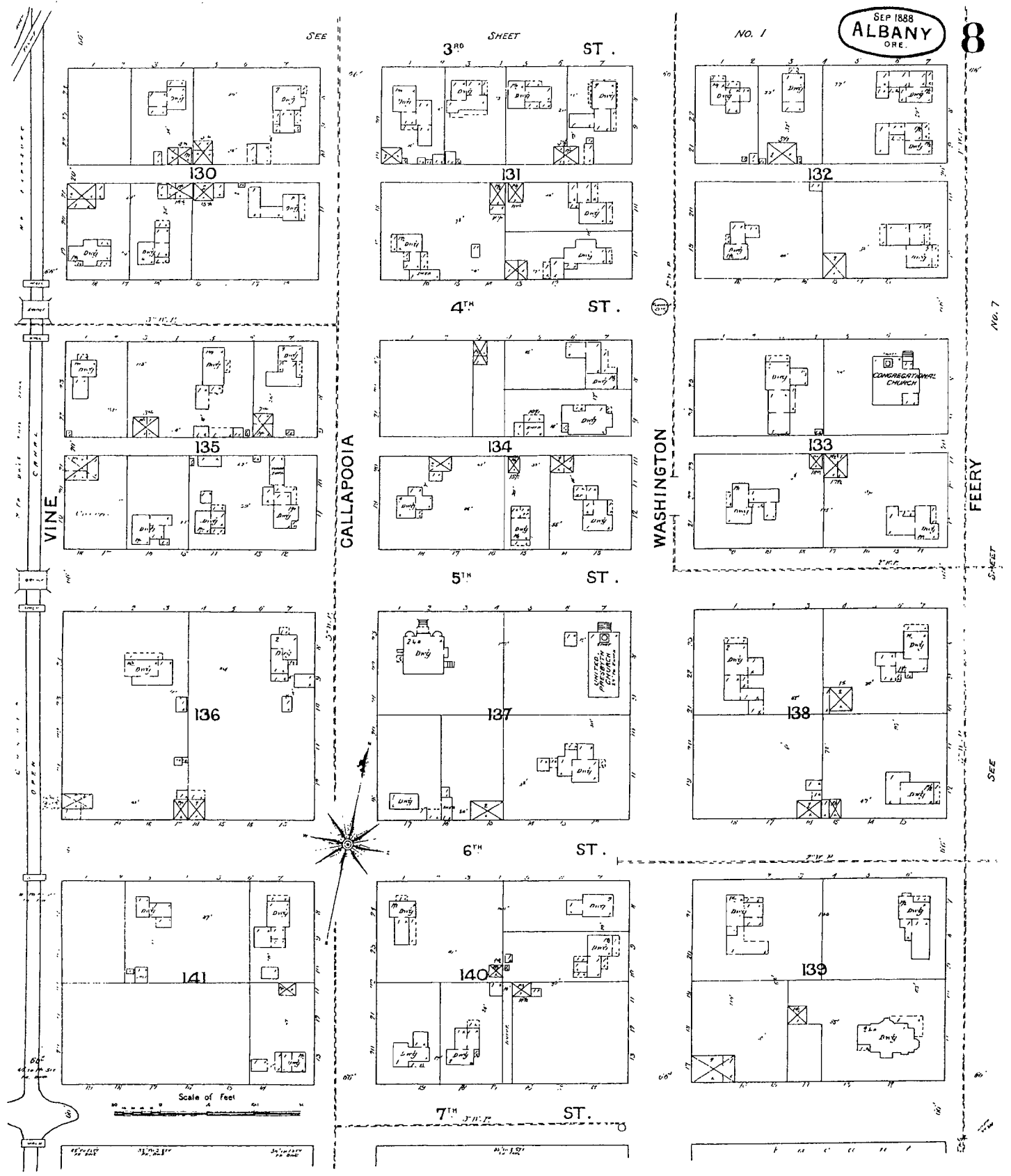

17/24/88







690 4th
(back to front)
W face (R)
C-4



640 4th
E face ②
C-2





PROVIDED BY CITY OF ALBANY



JESSE SKOUBO/DEMOCRAT-HERALD

This property at 2202 Willamette Ave. N.E. was cleaned up and the lot is now for sale.

8/17/09

Meth lab rehab



JESSE SKOUBO/DEMOCRAT-HERALD

Gayle Parrish spent the weekend repainting the onetime drug house in historically accurate colors.

Former drug factories livable again

BY ANNEMARIE KNEPPER

ALBANY DEMOCRAT-HERALD

It's taken more than three years and hundreds of hours of work, but the city of Albany finally has received notice all nine homes listed by the state as contaminated by meth are certified safe to live in.

The buildings were scattered all over the city and some date back to the turn of the 20th century.

The state Department of Human Services generated the list in 2006. It showed only homes where meth manufacturing operations had been busted by law enforcement, not homes where meth was being used.



Parrish's new home before it was decontaminated

"This isn't something that can just go in the Dumpster," she said.

Knowingly selling or renting a contaminated home is a felony.

Gayle Parrish bought her home in the 600 block of Fourth Avenue S.W. about a year ago.

The seller disclosed the home had been decontaminated.

Parrish said she likes the idea of living in a place that has been tested and now has a clean bill of health.

Without it, she says, who knows what happened in your home before you lived there?

"At least this way, if it's been

W.
tic P
he d
care
putt
Oban
a sliv
De
liber
presi
tratio
in th
that
to ge
the V
good
long
De
today
Whit
tion i
publi
town
try.
Th
NBC'
over t
suran
all pr
ices s
line, t
ment
tuall
elem
Off
looki
an A
lawm
for a v
lion u
stand
Sel
open
a sign
they c
Un
N.D.,
tives
with
electr
pecial
Wit
port f
opera
affilia
ment.
the ty
comp
expec

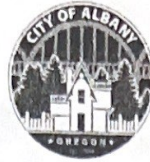

COMMUNITY DEVELOPMENT

333 Broadalbin Street SW, PO Box 490, Albany, Oregon 97321-0144 | BUILDING & PLANNING 541-917-7550

PLANNING APPLICATION

APPLICANT/OWNER & AUTHORIZING SIGNATURES

To be included with ALL City of Albany planning submittalsSend completed application and checklist(s) to cd.customerservice@cityofalbany.net.

- | | | |
|--|---|--|
| <input type="checkbox"/> Adjustment (AD)
<input type="checkbox"/> Alternative Setback
<input type="checkbox"/> Annexation (AN)
<input type="checkbox"/> Comprehensive Plan Amendment (CP)
<input type="checkbox"/> Map Amendment
<input type="checkbox"/> Map Amendment; concurrent w/zoning
<input type="checkbox"/> Text Amendment
<input type="checkbox"/> Conditional Use, circle one: Type II or III
<input type="checkbox"/> Existing Building: expand or modify
<input type="checkbox"/> New Construction
<input type="checkbox"/> Home Business (Type III only)
<input type="checkbox"/> Development Code Text Amendment (DC)
<input type="checkbox"/> Floodplain Development Permit (FP)
<input checked="" type="checkbox"/> Historic Review (HI)
<input type="checkbox"/> Exterior Alteration – residential, not visible from street (Type I)
<input type="checkbox"/> Exterior Alteration – all commercial and residential visible from street (Type III)
<input type="checkbox"/> New Construction (Type III or I-L)
<input type="checkbox"/> Demolition or Moving (Type III)
<input type="checkbox"/> Substitute Materials (Type III)
<input type="checkbox"/> Interpretation of Code (CI) | <input type="checkbox"/> Quasi-Judicial (Type II)
<input type="checkbox"/> Legislative (Type IV)
<input type="checkbox"/> Land Division (check all that apply)
<input type="checkbox"/> Partition (PA)
<input type="checkbox"/> Tentative Plat (Type I-L)
<input type="checkbox"/> Tentative Plat PD or CD (Type III)
<input type="checkbox"/> Final Plat (Type I)
<input type="checkbox"/> Subdivision (SD)
<input type="checkbox"/> Tentative Plat (Type I-L)
<input type="checkbox"/> Tentative Plat PD or CD (Type III)
<input type="checkbox"/> Final Plat (Type I)
<input type="checkbox"/> Tentative Re-plat Type I-L (RL)
<input type="checkbox"/> Modification to Approved Site Plan or Conditional Use
<input type="checkbox"/> Natural Resource Boundary Refinement (NR)
<input type="checkbox"/> Natural Resource Impact Review (NR)
<input type="checkbox"/> Non-Conforming Use (MN)
<input type="checkbox"/> Planned Development (PD)
<input type="checkbox"/> Preliminary (Type III)
<input type="checkbox"/> Final (Type I)
<input type="checkbox"/> Property Line Adjustment (LA)
<input type="checkbox"/> Site Plan Review (SP)
<input type="checkbox"/> Accessory Building
<input type="checkbox"/> Change of Use, Temporary or Minor Developments | <input type="checkbox"/> Manufactured Home Park
<input type="checkbox"/> Modify Existing Development
<input type="checkbox"/> Parking Area Expansion (only)
<input type="checkbox"/> New Construction
<input type="checkbox"/> Tree Felling
<input type="checkbox"/> Temporary Placement (TP)
<input type="checkbox"/> Urban Growth Boundary (UGB)
<input type="checkbox"/> Vacation (VC)
<input type="checkbox"/> Public Street or Alley
<input type="checkbox"/> Public Easements
<input type="checkbox"/> Variance (VR)
<input type="checkbox"/> Major Variance (Type II)
<input type="checkbox"/> Minor Variance (Type I-L)
<input type="checkbox"/> Willamette Greenway Use (WG)
<input type="checkbox"/> Zoning Map Amendment (ZC)
<input type="checkbox"/> Quasi-Judicial (Type IV)
<input type="checkbox"/> Legislative (Type IV)
<input type="checkbox"/> Other Required (check all that apply)
<input type="checkbox"/> Design Standards
<input type="checkbox"/> Hillside Development
<input type="checkbox"/> Mitigation
<input type="checkbox"/> Parking/Parking Lot
<input type="checkbox"/> Traffic Report
<input type="checkbox"/> Other _____ |
|--|---|--|

Location/Description of Subject Property(s)

Site Address(es): 640 SW 4th Ave, Albany OR 97321
 Assessor's Map No(s): 11504W12-AA-04400 Tax Lot No(s): 00846-131256
 Comprehensive Plan designation: residential low density Zoning designation: Hackleman/Mantith
 Size of Subject Property(s): 6,767 sq ft Related Land Use Cases: (3) Hi-02-14, Hi-04-03, Hi-11-11
 Project Description: Construct small 12x16 shed for tool storage

 Historic Overlay Natural Resource Overlay District Floodplain or Floodway Overlaycd.cityofalbany.net

Applicant Information (must be signed)

Name: Jacob Thompson Signature: [Signature]
 Mailing Address: 640 SW 4th Ave Date: _____
 City: Albany State: OR Zip: 97321
 Phone #: 253-590-7861 Fax #: _____ Email: jake.thompson592@gmail.com

File #(s): _____ Date Fee & Application Received: _____
 Pre-App File #(s): _____ Pre-App Meeting Date: _____
 Amount Paid: _____ Received By: _____

Property Owner Information (must be signed)

Same as Applicant

Name: _____ Signature: _____
 Mailing Address: _____ Date: _____
 City: _____ State: _____ Zip: _____
 Phone #: _____ Fax #: _____
 Email: _____

Authorized Agent or Representative (must be signed, if applicable)

Choose One: Engineer Architect Other _____

Name: _____ Signature: _____
 Mailing Address: _____ Date: _____
 City: _____ State: _____ Zip: _____
 Phone #: _____ Fax #: _____
 Email: _____
 Relationship to property owner(s): _____

Electronic Plans Representative (if different from applicant)

IF MORE THAN ONE, PROVIDE THE FOLLOWING INFORMATION FOR EACH; THEY WILL BE SENT ALL CITY NOTICES

Choose One: Engineer Architect Other _____

Name: _____ Signature: _____
 Mailing Address: _____ Date: _____
 City: _____ State: _____ Zip: _____
 Phone #: _____ Fax #: _____
 Email: _____

Other Representative (must be signed, if applicable)

Choose One: Engineer Architect Other _____

Name: _____ Signature: _____
 Mailing Address: _____ Date: _____
 City: _____ State: _____ Zip: _____
 Phone #: _____ Fax #: _____
 Email: _____

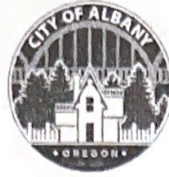

COMMUNITY DEVELOPMENT

333 Broadalbin Street SW, PO Box 490, Albany, Oregon 97321-0144 | BUILDING & PLANNING 541-917-7550

Historic Review of New Construction

Checklist, Overview, and Review Criteria

INFORMATION AND INSTRUCTIONS:

- See fee schedule for filing fee (*subject to change every July 1*): staff will contact you for payment after submittal.
- All plans and drawings must be to scale, and review criteria responses should be provided as specified in this checklist.
- Email all materials to cd.customerservice@cityofalbany.net. Please call 541-917-7550 if you need assistance.
- Depending on the complexity of the project, paper copies of the application may be required.
- Before submitting your application, please check the following list to verify you are not missing essential information. An incomplete application will delay the review process.

HISTORIC REVIEW OF NEW CONSTRUCTION SUBMITTAL CHECKLIST

PLANNING APPLICATION FORM WITH AUTHORIZING SIGNATURES.

PROPERTY AND PROJECT INFORMATION. See page 2.

REVIEW CRITERIA RESPONSES.

On a separate sheet of paper, prepare detailed written responses, using factual statements (called findings of fact), to explain how the new construction complies with each of the following review criteria (ADC 7.270). Each criterion must have at least one finding of fact and conclusion statement. See page 2 for criteria and page 3 for an example.

The Community Development Director or the Landmarks Commission must find that the request meets the following applicable criteria in order to approve the new construction request:

1. Within the Monteith and Hackleman Districts:
 - a. The development maintains any unifying development patterns such as sidewalk and street tree location, setbacks, building coverage, and orientation to the street.
 - b. The structure is of similar size and scale of surrounding buildings, and as much as possible reflects the craftsmanship of those buildings.
 - c. Building materials are reflective of and complementary to existing buildings within the district.
2. Within the Downtown District:
 - a. The development maintains the horizontal elements of adjacent buildings. (These horizontal elements can include an alignment of window frames, roof lines, facades, and clear distinction between first floors and upper floors.)
 - b. The development maintains other historic patterns, such as the horizontal/vertical pattern of upper story windows and the pattern of entrances along the street.
 - c. Building materials are reflective of and complementary to existing historic buildings within the district.
 - d. Lot coverage, setbacks, and building orientation to the street are consistent with the surrounding

cd.cityofalbany.net



development patterns.

- e. The development maintains the pedestrian scale and orientation of the Downtown District.

- A **SITE PLAN** showing the location of the structure on the site, setbacks, building dimensions, the location of driveways and landscape areas, and the general location of structures on adjacent lots.
- CONSTRUCTION PLANS/ELEVATION DRAWINGS** showing detailed building elevations, dimensions, materials, and architectural elements.

Note: Some properties may have covenants or restrictions, which are private contracts between neighboring landowners. These frequently relate to density, minimum setbacks, or size and heights of structures. While these covenants and restrictions do not constitute a criterion for a City land use decision, they may raise a significant issue with regard to the City's land use criteria. It is the responsibility of the applicant to investigate private covenants or restrictions.

PROPERTY AND PROJECT INFORMATION

Submit the following information (separately or on this sheet):

1. Historic District:

Monteith Hackleman Downtown Local Historic Commercial/ Airport
 2. Historic rating:

Historic Contributing Historic Non-Contributing Non-Historic (post 1945)
 3. Architectural Style(s): Vernacular Constructed: 1870
 4. Please describe the proposal: Construct small 12x16 shed for tool storage
-

HISTORIC REVIEW PROCESS OVERVIEW

The City reviews new structures over 100 square feet within historic districts in order to ensure they are compatible with the character of that district. The Director will approve applications for new construction but may decide to refer the application the landmarks commission for a decision. For staff level reviews, the applicant and property owners within 100 feet of the subject property will receive notice of the proposal. For commission reviews, the notice area is 300 feet.

Before submitting your application, a pre-application meeting with the preservation planner is recommended. Projects other than single-unit uses may also require other land use reviews and a pre-application meeting with a team of City representatives to determine what land use issues exist and if any other land use approvals may be required.

New construction will be approved if the review body finds the application satisfied the review criteria (on page 2), possibly with conditions of approval. Staff may require guarantees and evidence that conditions are complied with.

Landmarks Commission decisions may be appealed to the Albany City Council. Staff decisions may be appealed to the Landmarks Commission.

EXAMPLE OF FINDINGS OF FACT

Criteria for Findings of Fact:

Land use applications must include information that explains the intent, nature, and proposed use of the development, and other pertinent information that may have bearing on the action to be taken by the review authority. To be approved, a Historic Review application must address and demonstrate compliance with the applicable review criteria in Article 7 and related requirements. If the applicant's submittal is unclear or insufficient to demonstrate the review criteria are satisfied, the application will be delayed or denied.

Format for Findings of Fact:

Statements addressing individual criteria must be in a “finding of fact” format. A finding of fact consists of two parts:

- Factual information such as the distance between buildings, the width and type of streets, the particular operating characteristics of a proposed use, etc. Facts should reference their source: on-site inspection, a plot plan, City plans, etc.
- An explanation of how those facts result in a conclusion supporting the criterion.

Example:

Criterion: The proposed alteration will cause the structure to more closely approximate the historical character, appearance, or material composition of the original structure than the existing structure.

Fact: The Cultural Resource Inventory indicates that the house was constructed c.1885 and the style is a Western Farmhouse. The decorative features noted are rectangular bays on the north and east sides with panels, turned porch columns, and a fixed window with a diamond shaped pattern on the east side. Sanborn Fire map research indicates that the porch originally extended the full length of the west wing of the house.

This application proposes to restore the front porch to the full length of the west wing of the house. Additional porch columns are proposed to match the existing turned porch columns; a hipped roof is proposed consistent with existing entry and bays and Sanborn maps. The current porch, which now only covers the front door, is more of a covered entry than a porch. The balusters are a connected “sawn” design (rather than turned) that was typical in the late 19th century. (SEE ATTACHED DRAWING.)

Conclusion: Extending the porch to its original size will cause the structure to more closely approximate its historic character and appearance.

640 SW 4th Ave Site Plan

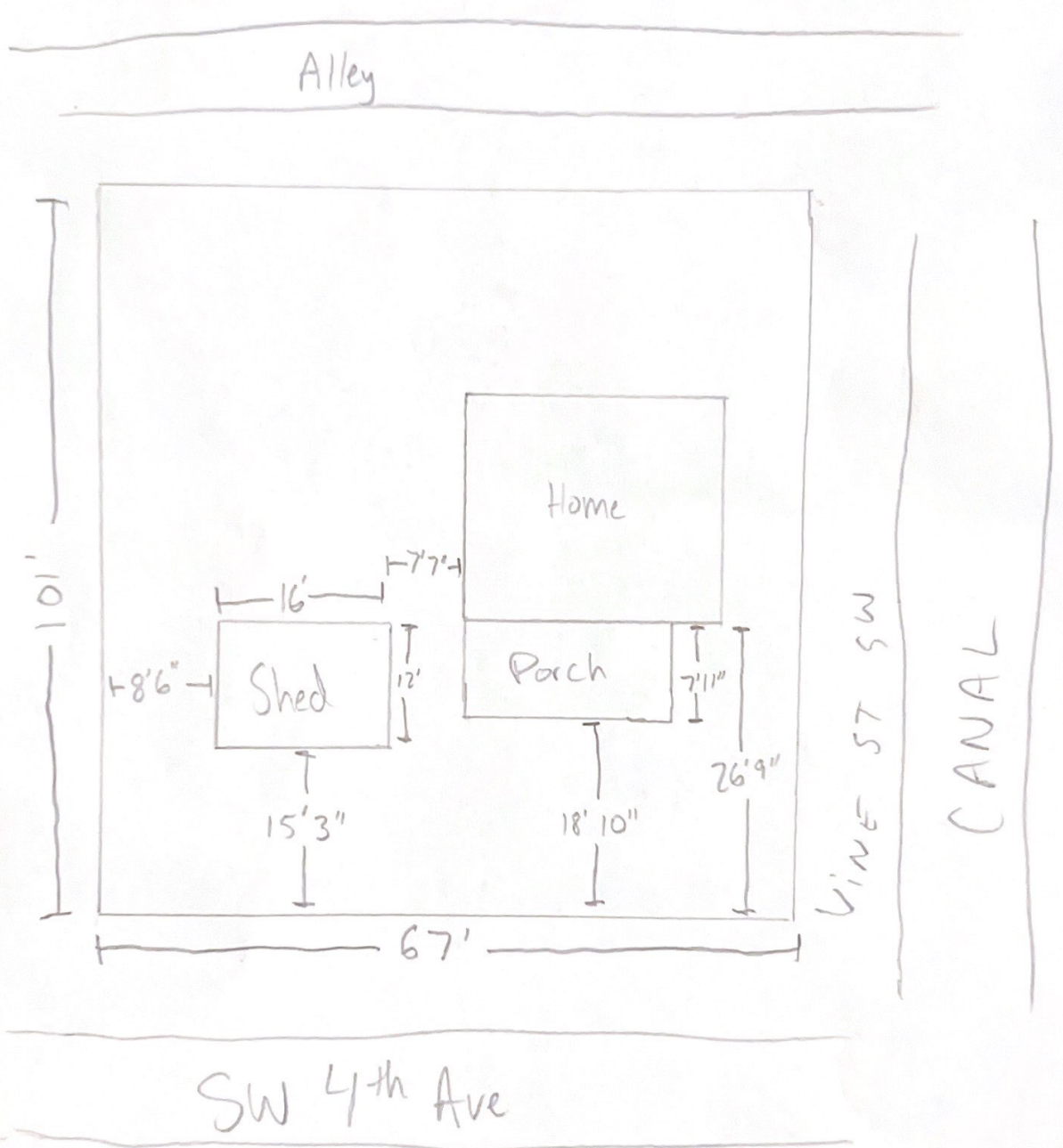

Review Criteria

Criterion: The development maintains any unifying development patterns such as sidewalk and street tree location, setbacks, building coverage, and orientation to the street.

Fact: There are many homes with a range of different characteristics in this area. Some have street trees, some do not. Some homes face 4th street, others face the alley, and several lots in the area are industrial (such as the power plant/water treatment plant) or vacant. There are a number of homes with storage sheds, garages, basements, and garages converted to separate living units as well.

Conclusion: The addition of a storage shed will not cause a disruption to the development pattern of the neighborhood. No trees will need to be removed, and all proper setbacks are adhered to.

Criterion: The structure is of similar size and scale of surrounding buildings, and as much as possible reflects the craftsmanship of those buildings.

Fact: The scale/size of buildings around the area consist mostly of 2 story homes with many having detached garages, sheds, and/or ADU's.

The craftsmanship/style of the homes varies widely. For example, some homes use gable style roofs, and others use hip pitch. Some homes have bay windows, others do not. Additionally, there is a power plant directly across the street, and a vacant lot a couple of houses down.

For this shed, I have chosen to select materials that reflect the craftsmanship of the surrounding buildings as much as possible. For example, the shed will have a gable style roof to match our home, double hung windows, flower pots under windows, and matching paint/trim with our main home.

Conclusion: Building this shed will allow our home to more closely approximate the surrounding buildings (to the extent possible), and especially our own home. It will not cause a disruption in the flow of the neighborhood.

Criterion: Building materials are reflective of and complementary to existing buildings within the district.

Fact: The surrounding homes use a mixture of various building materials. For example, a survey of homes in the area show that some of the siding used includes dutch lap, clapboard, shake, T-111, brick, and stucco. In some instances, homes use a combination of styles where they have been added on to. Windows appear to be mostly hung, however not all are this way. Roofing materials appear to be primarily shingles, with some outbuildings and other structures having flat roofing material.

Our shed will have Gable style roof with asphalt shingles, double hung windows, T-111 siding, with conventional stick built framing. The front door will be a standard 36" x 80" entry 6 panel steel door. The rear doors will consist of french doors, allowing for larger tools to be taken in/out of the shed. And again, we will paint the shed to match our home.

Conclusion: The building materials of the shed are reflective and complementary to existing buildings in the area.



www.Construct101.com



Legal:

The content of this guide may not be sold, modified, or distributed in anyway without the expressed written consent of the publisher. Reprinting, copying, or any other form of distribution for commercial or non-commercial purposes is strictly prohibited and will be prosecuted.

Disclaimer:

Every attempt has been made to provide the most accurate information as possible. However, the publisher accepts no liability for any wrong information as a result of purchasing and / or reading this guide.

You can follow this guide at your own risk the publisher accepts no responsibility for any injury to any person.

Copyright © www.Construct101.com

All rights reserved

ISBN-13:

ISBN-10:



www.Construct101.com

12x16 Shed Plans – Gable Design

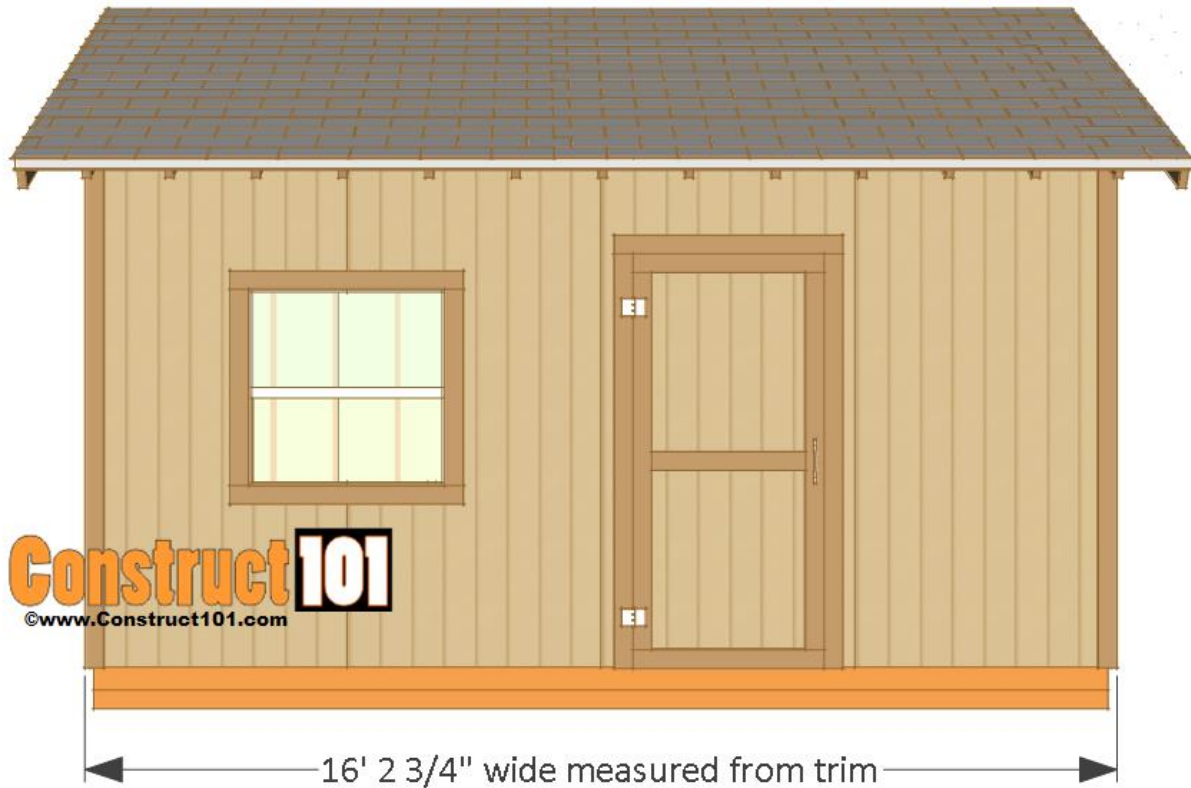

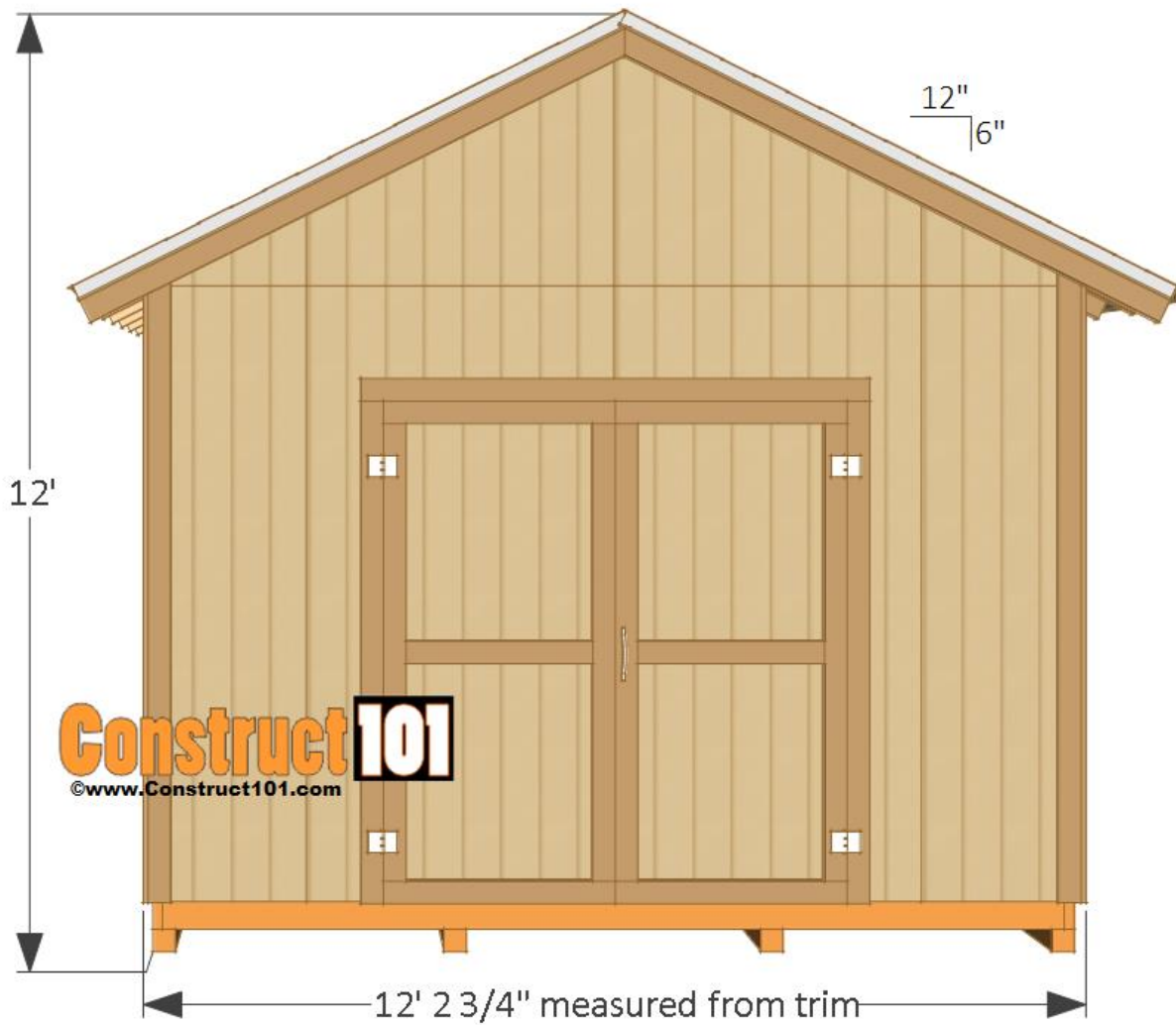

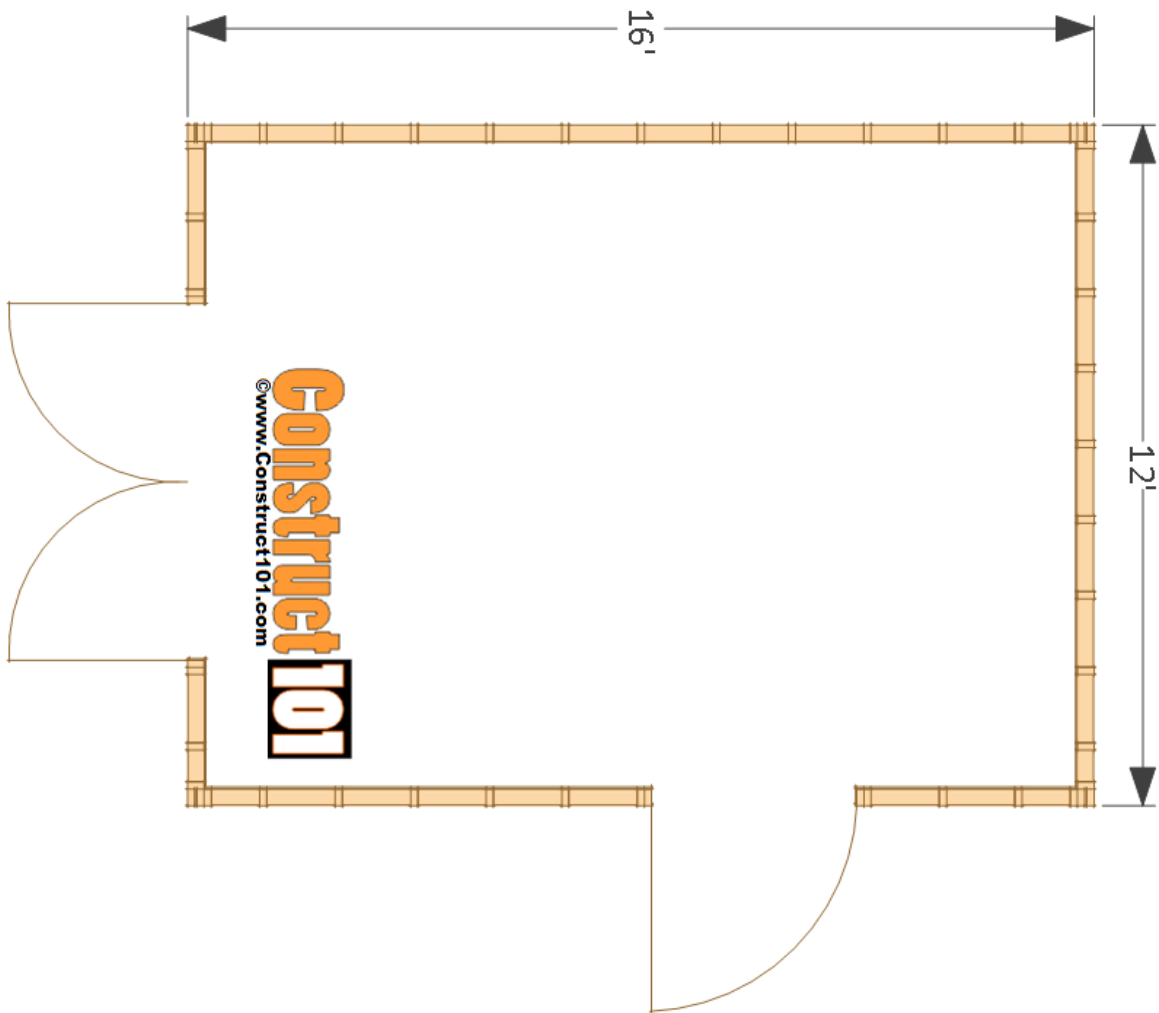



www.Construct101.com

12x16 Shed Plans – Gable Design – Material List

Shopping List

2 – pressure treated 2x6 – 16'

13 – pressure treated 2x6 – 12'

4 – pressure treated 4x4 – 16'

6 – 2x4 – 16'

93 – 2x4 – 8'

19 – 2x4 – 12'

4 – 2x6 – 8'

10 – 1x4 – 8'

6 – 3/4" tongue and groove plywood – 4'x8' sheets

17 – t1-11 exterior siding plywood – 4'x8' sheets

10 – 1/2" plywood – 4'x8' sheets

shingles

roof tacks

roofing felt

staples

drip edge

3 1/2" galvanized nails

1 1/4" galvanized finishing nails

2" galvanized nails

2" deck screws

6 – door hinges

2 – door handles



www.Construct101.com

Cutting List

2 – pressure treated 2×6 – 16'

13 – pressure treated 2×6 – 11' 9"

4 – pressure treated 4×4 – 16'

4 – 2×4 – 16'

2 – 2×4 – 15' 5"

54 – 2×4 – 7' 6"

15 – 2×4 – 12'

4 – 2×4 – 11' 5"

26 – 2×4 – 7' 8 11/16"

13 – 2×4 – 2' 8 3/8"

16 – 2×4 – 2' 1 3/4"

4 – 2×6 – 7' 8 11/16"

10 – 1×4 – 8' (cut to size)

6 – 3/4" tongue and groove plywood – 4'x8' sheets (cut to size)

17 – t1-11 exterior siding plywood – 4'x8' sheets (cut to size)

10 – 1/2" plywood – 4'x8' sheets (cut to size)

Construct101

www.Construct101.com

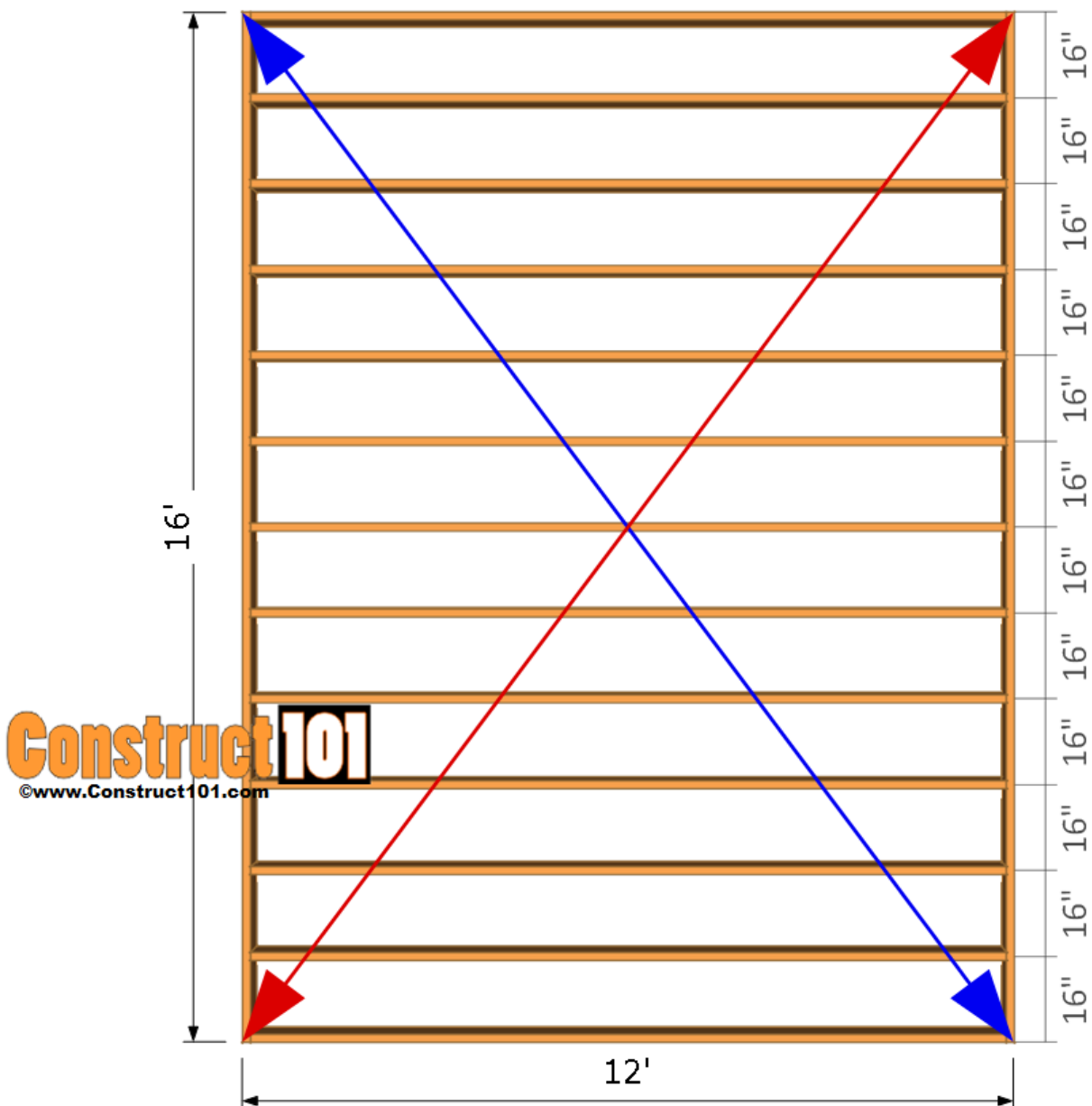

The shed floor is built with pressure treated 2×6's and pressure treated 4×4's.

Cut two 2×6's to 16' long for the band. Cut thirteen 2×6's to 11' 9" long for the floor joist. Nail 3 1/2" nails through the 2×6 band and into the floor joist. Floor joist 16" O.C.

Attach the 16' long 4×4 pressure treated skids to the bottom of the floor frame. Square out the floor frame by measuring diagonally until both sides measure the same. Secure the 4×4 skids by nailing 3 1/2" nails through the floor frame and into the 4×4 skids.

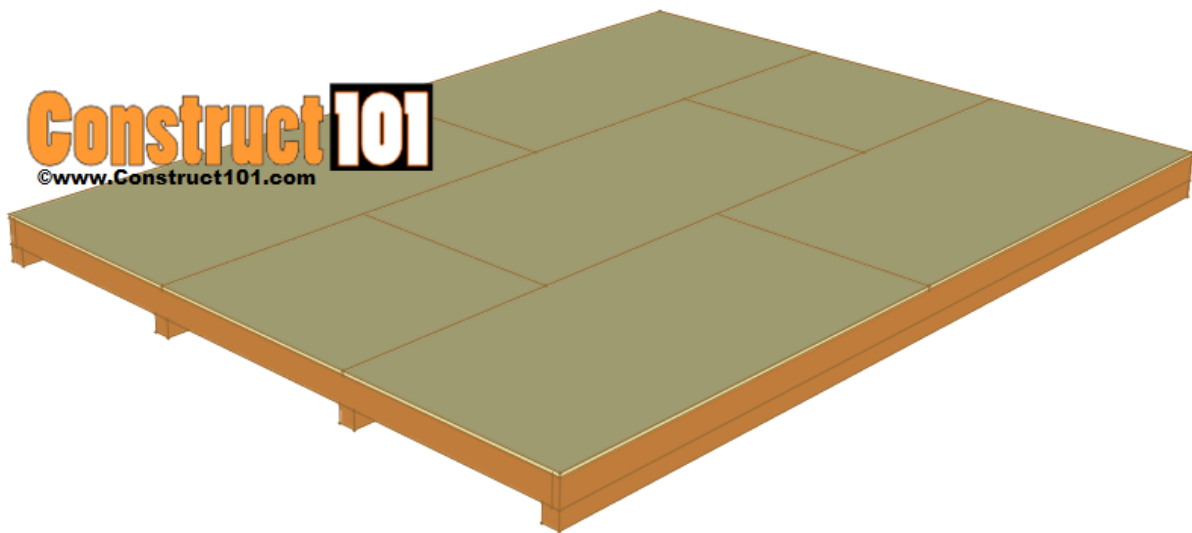

Cut to size and install the 3/4" tongue and groove plywood. Secure the floor plywood with 2" deck screws.

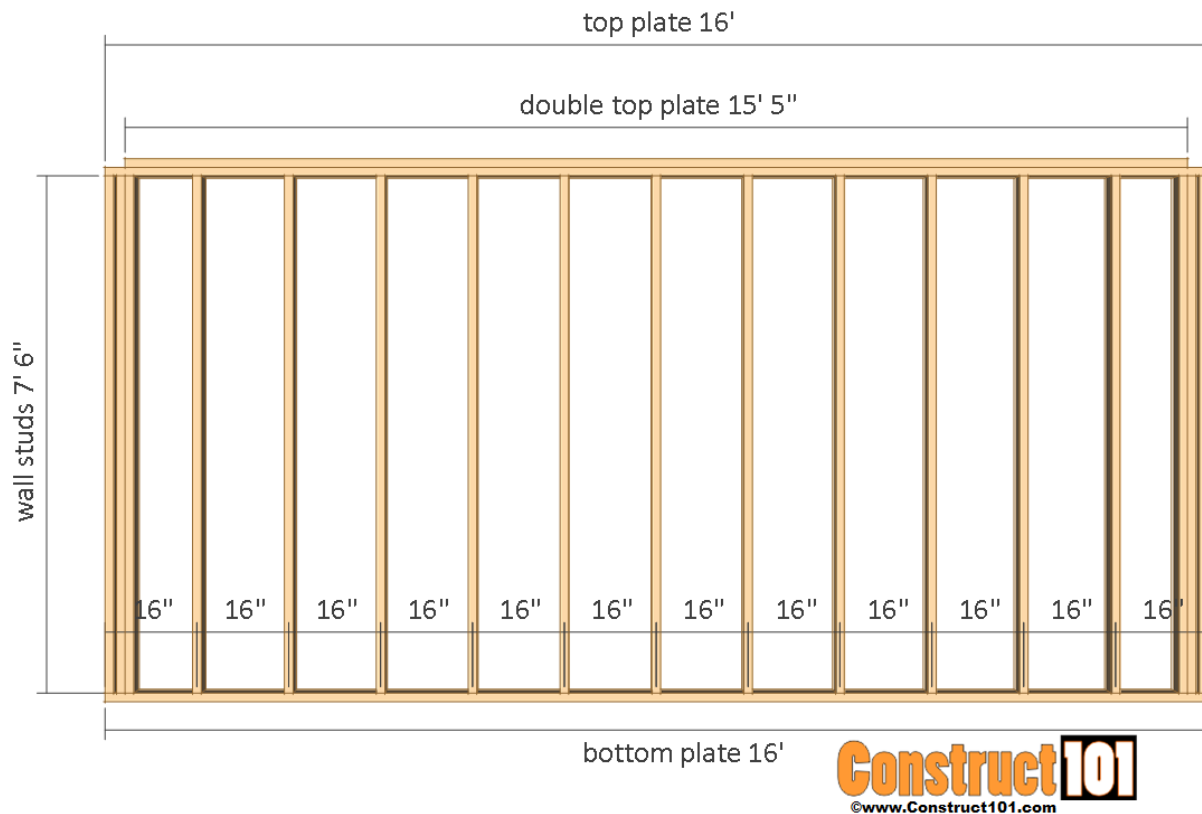

The front and back wall frame is built using 2x4 lumber.

The wall studs are 16" O.C.

Assemble the back wall frame as shown on illustration above (see illustration below for close up view).

The front wall frame will have a door and window, for instructions on framing the door and window see attached pages:

- Shed Door Plans
- Wall Framing – Adding a Shed Window

Assemble the front and back wall frame using 3 1/2" nails.

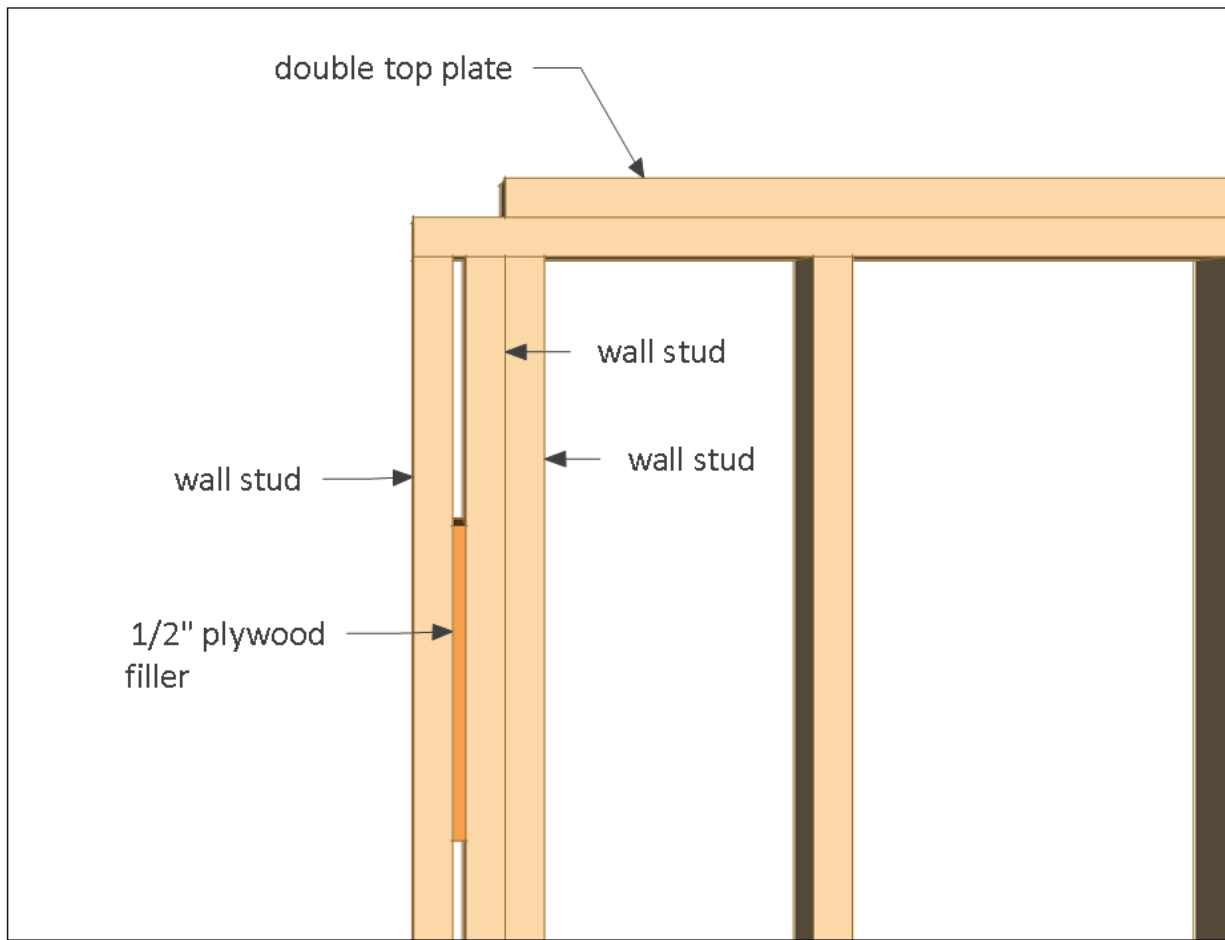

Here is a close up look of the front and back wall frame ends.

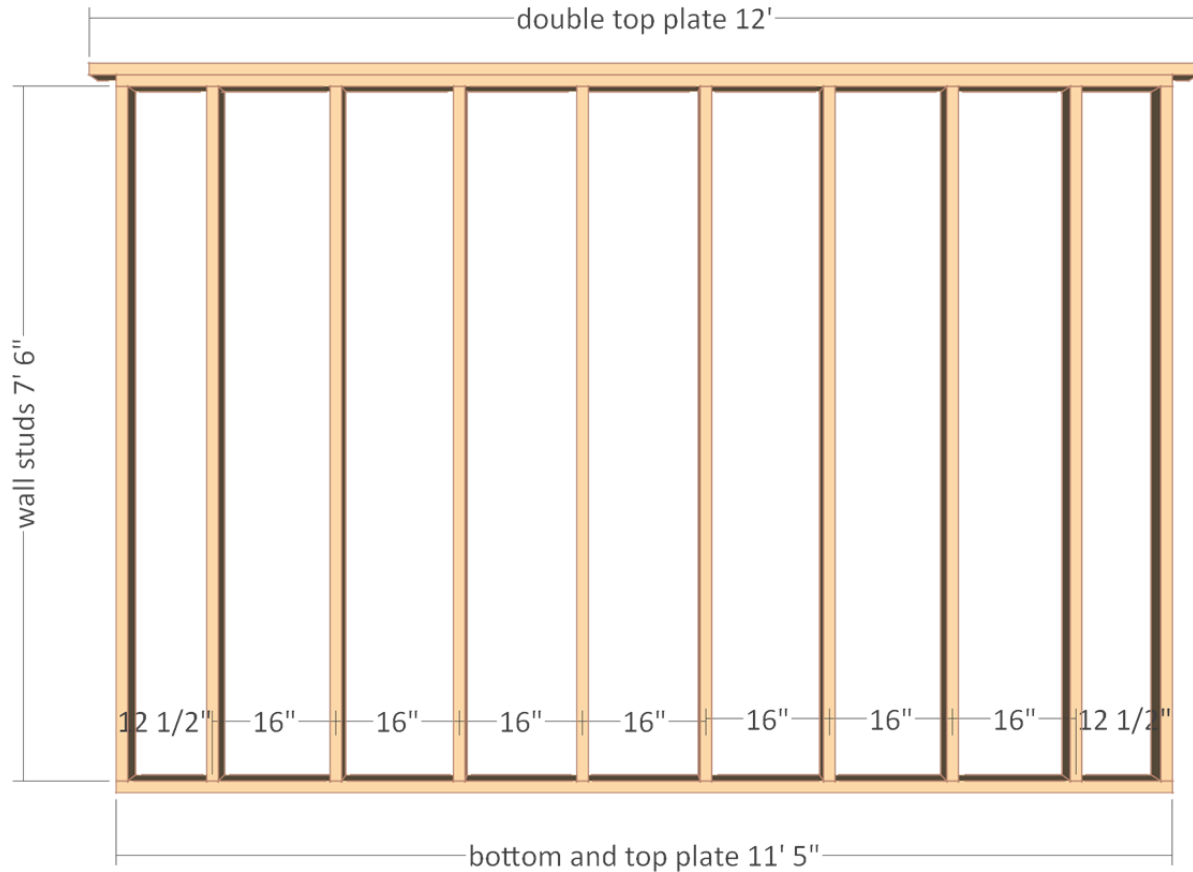

Cut the 2×4's as shown on illustration above for the side walls.

Wall studs are 16" O.C.

If you will be adding a double door to the side wall of the shed see the page attached for details: Shed Door Plans

Assemble the side wall frame using 3 1/2" nails.

Construct101

www.Construct101.com

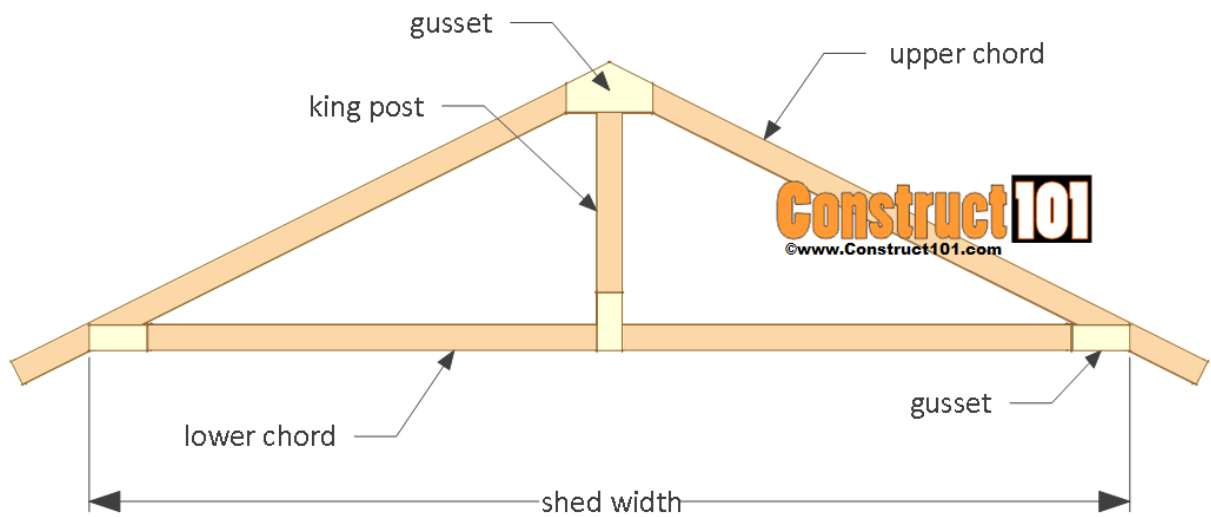

See illustration above for truss details.

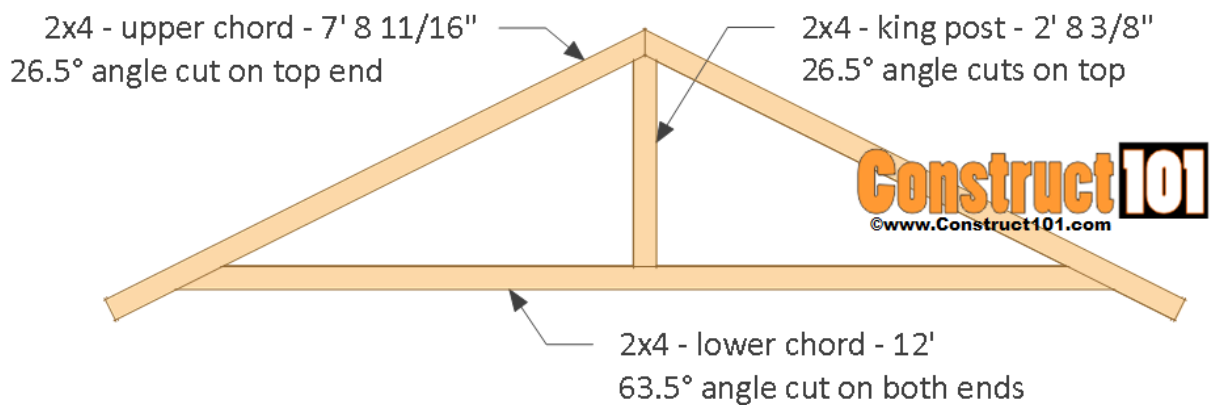

The truss is built using 2x4's.

Cut the 2x4's as shown on illustration above. The truss are assembled using 1/2" plywood gussets. Nail 2" nails through the gusset and into the truss.

Construct101

www.Construct101.com

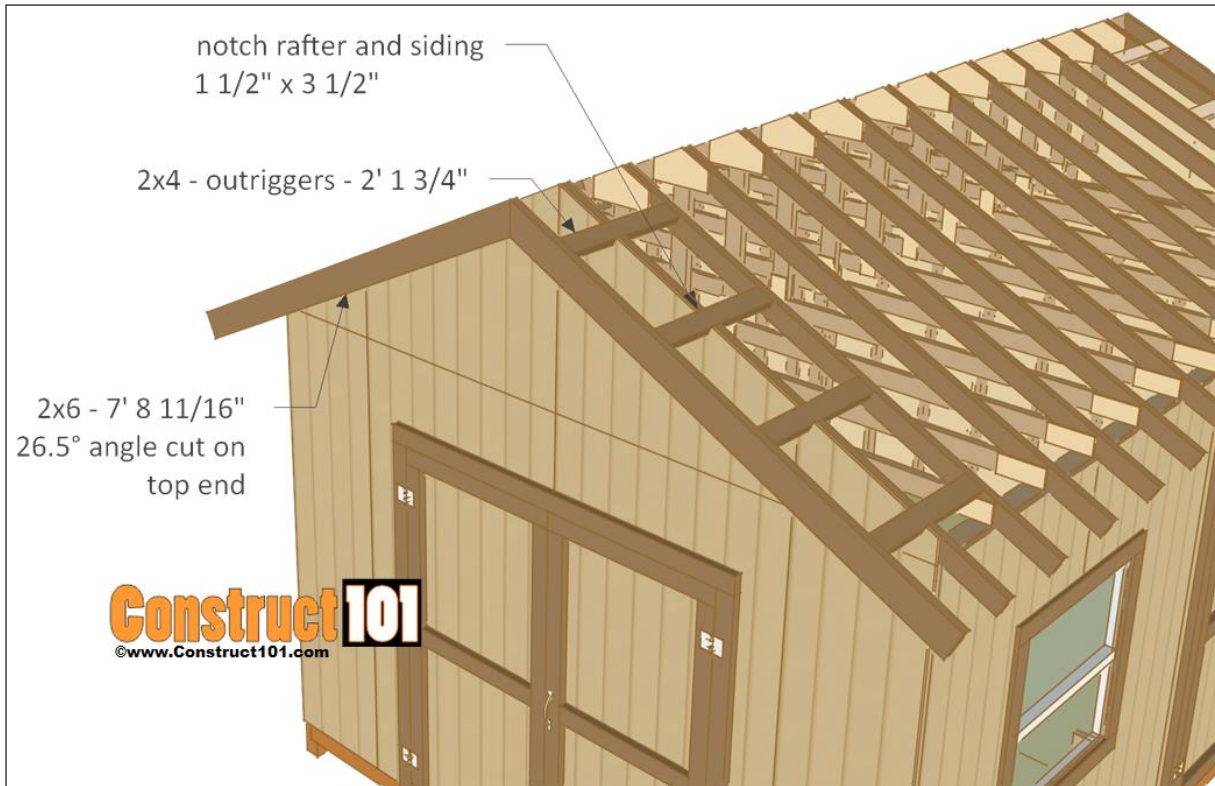

Attach the truss to the shed 16" O.C. Toenail 3 1/2" nails through the truss and into the wall frame.

To build the 1' overhand cut 2x4's to 2' 1 3/4" long for the outriggers. Notch as shown on illustration above and install the outriggers using 3 1/2" nails.

Once the outriggers have been installed cut to size the 2x6 roof trim as shown above and install with 3 1/2" nails.

Install siding using 1 1/4" finishing nails.

Install doors, and windows.

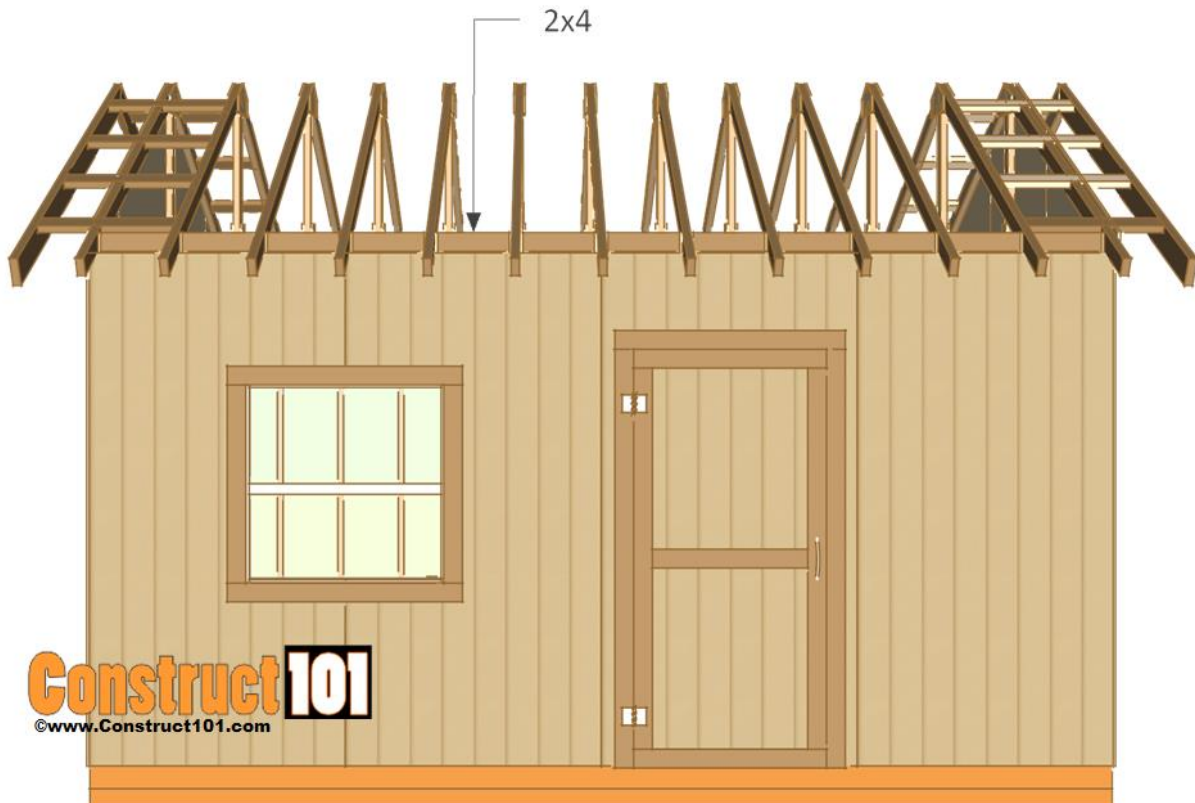

Cut 2x4's to size and install between the rafters with 3 1/2" nails.



Cut t1-11 siding to size and install between the rafters. Use 1 1/4" finishing nails to install.

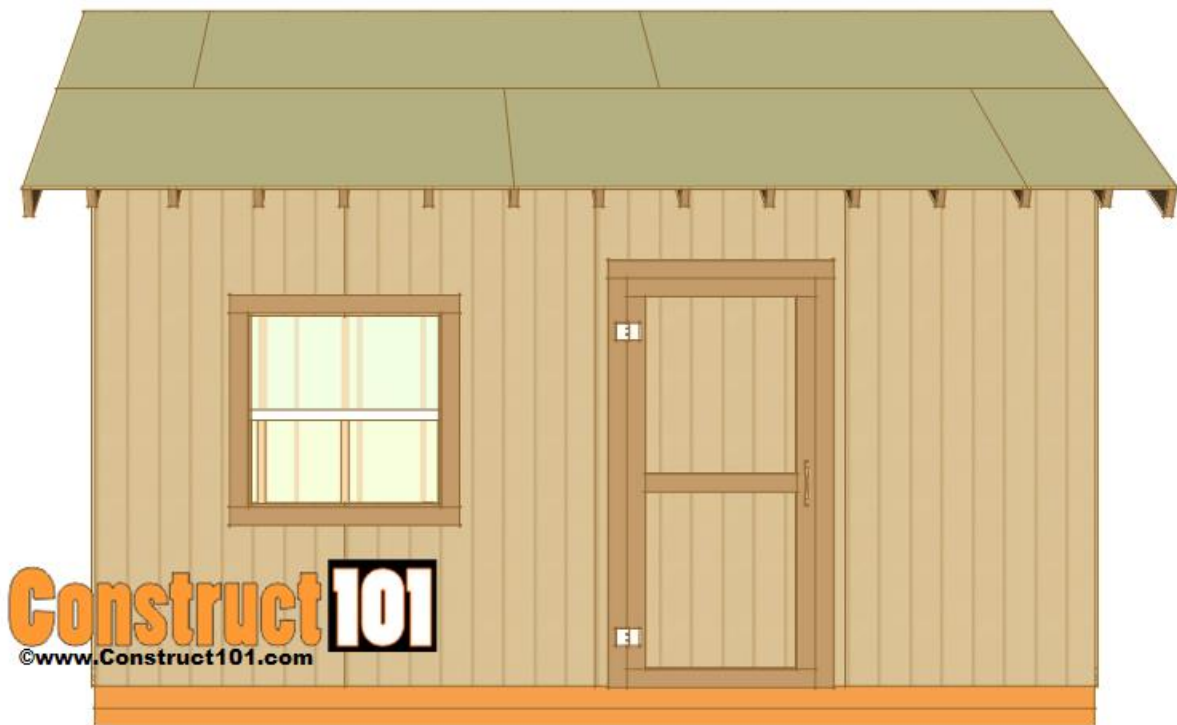

Measure, cut, and install the 1/2" plywood for the roof deck.

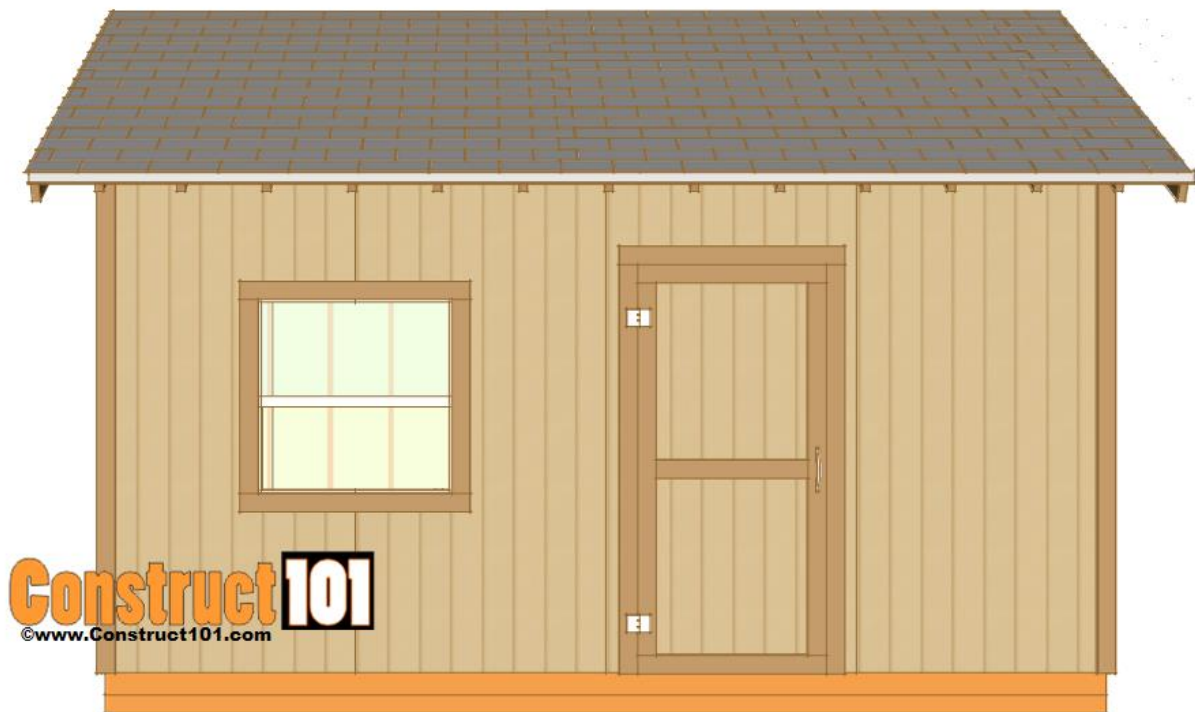

Install roofing felt, drip edge, and shingles.

Install 1×4 trim.

640 SW 4th Ave Site Plan

